



The Global Language of Business

# Cash Processing Business Message Standard (BMS)

*Release 3.6, Ratified, Mar 2023*



## Document Summary

Document Item	Current Value
Document Name	Cash Processing Business Message Standard (BMS)
Document Date	Mar 2023
Document Version	3.6
Document Issue	1
Document Status	Ratified

## Work Request Reference

Date of WR Submission to GSMP:	WR Submitter(s):	Refer to Work Request (WR) Number(s):
15-Sep-2016	GS1 France	16-000428
22-Jun-2018	GS1 Italy	18-000141
03-Oct-2018	GS1 GO	18-000319

## Business Requirements Document (BRAD) Reference

BRAD Title	BRAD Issue Date	BRAD Version
Cash Processing Machines Communication	June 2017	Draft 3

## Document Change History

Date of Change	Version	Changed By	Reason for Change	Summary of Change
08-Aug-2017	BMS 3.3 – Issue 1	Ewa Iwicka	BMS Release 3.3	See summary of changes
15-Oct-2018	BMS 3.4 – Issue 1	Ewa Iwicka	BMS Release 3.4	See summary of changes
04-Feb-2021	BMS 3.5 – Issue 1	Miklos Bolyky	BMS Release 3.5	See summary of changes
05-Jan-2022	BMS 3.5.1 – Issue 1	Miklos Bolyky	BMS Release 3.5.1	See summary of changes
01-Mar-2023	BMS 3.6 – Issue 1	Miklos Bolyky	BMS Release 3.6	See summary of changes

## Disclaimer

GS1®, under its IP Policy, seeks to avoid uncertainty regarding intellectual property claims by requiring the participants in the Work Group that developed this **Cash Processing Business Message Standard (BMS)** to agree to grant to GS1 members a royalty-free licence or a RAND licence to Necessary Claims, as that term is defined in the GS1 IP Policy. Furthermore, attention is drawn to the possibility that an implementation of one or more features of this Specification may be the subject of a patent or other intellectual property right that does not involve a Necessary Claim. Any such patent or other intellectual property right is not subject to the licencing obligations of GS1. Moreover, the agreement to grant



licences provided under the GS1 IP Policy does not include IP rights and any claims of third parties who were not participants in the Work Group.

Accordingly, GS1 recommends that any organization developing an implementation designed to be in conformance with this Specification should determine whether there are any patents that may encompass a specific implementation that the organisation is developing in compliance with the Specification and whether a licence under a patent or other intellectual property right is needed. Such a determination of a need for licencing should be made in view of the details of the specific system designed by the organisation in consultation with their own patent counsel.

THIS DOCUMENT IS PROVIDED "AS IS" WITH NO WARRANTIES WHATSOEVER, INCLUDING ANY WARRANTY OF MERCHANTABILITY, NONINFRINGEMENT, FITNESS FOR PARTICULAR PURPOSE, OR ANY WARRANTY OTHER WISE ARISING OUT OF THIS SPECIFICATION. GS1 disclaims all liability for any damages arising from use or misuse of this Standard, whether special, indirect, consequential, or compensatory damages, and including liability for infringement of any intellectual property rights, relating to use of information in or reliance upon this document.

GS1 retains the right to make changes to this document at any time, without notice. GS1 makes no warranty for the use of this document and assumes no responsibility for any errors which may appear in the document, nor does it make a commitment to update the information contained herein.

GS1 and the GS1 logo are registered trademarks of GS1 AISBL.

# Table of Contents

- 1 Business Domain View ..... 6**
  - 1.1 Introduction ..... 6
  - 1.2 References ..... 6
- 2 Business Context ..... 6**
- 3 Business Transaction View ..... 7**
  - 3.1 Business Transaction - counting, sorting and stacking of cash..... 8
  - 3.2 Business Transaction - packing of cash ..... 9
- 4 Business Information View ..... 10**
  - 4.1 Cash Count Notification..... 10
    - 4.1.1 Cash Count Notification Line Item ..... 12
    - 4.1.2 Cash Count Notification Line Item Details..... 13
  - 4.2 Cash Count Report ..... 15
    - 4.2.1 Cash Count Report Line Item..... 17
  - 4.3 Cash Count Statistic Report ..... 19
    - 4.3.1 Cash Count Statistic Report Line Item ..... 22
  - 4.4 Cash Packaging Report ..... 24
    - 4.4.1 Cash Packaging Report Line Item..... 26
    - 4.4.2 Cash Packaging Report Line Item Details ..... 28
    - 4.4.3 Cash Packaging Report – Output Logistic Unit..... 30
  - 4.5 Cash Processing Machines Common..... 31
    - 4.5.1 Cash Processing Machines Common – Cash Processing Event ..... 31
    - 4.5.2 Cash Processing Machines Common – Cash Packaging Trade Item ..... 32
    - 4.5.3 Cash Processing Machines Common – Cash Processing Station ..... 33
    - 4.5.4 Cash Processing Machines Common – Deposit Unit Identification ..... 34
    - 4.5.5 Cash Processing Machines Common – Operator of Processing Station ..... 35
    - 4.5.6 Cash Processing Machines Common – Cash Processing Machines Code ..... 36
  - 4.6 Enumerations (message specific) ..... 38
  - 4.7 Code Lists ..... 38
- 5 Business Message Examples ..... 38**
  - 5.1 Example 1 ..... 38
  - 5.2 Example 2 ..... 44
  - 5.3 Example 3 ..... 47
  - 5.4 Example 4 ..... 51
- 6 Implementation Considerations..... 57**
  - 6.1 User Guide ..... 57
  - 6.2 Message Specific Considerations ..... 57
- 7 Summary of Changes ..... 57**
  - 7.1 BMS Release 3.3 ..... 57
  - 7.2 BMS Release 3.4 ..... 58
  - 7.3 BMS Release 3.5 ..... 58
  - 7.4 BMS Release 3.5.1 ..... 58



---

7.5	BMS Release 3.6 .....	58
<b>8</b>	<b>Appendices .....</b>	<b>58</b>
<b>9</b>	<b>Acknowledgements.....</b>	<b>58</b>
9.1.1	Work Group .....	58
9.1.2	Development Team Members .....	59

# 1 Business Domain View

## 1.1 Introduction

### Message Definition

#### Cash Count Notification Message Definition

The Cash Count Notification message provides report on counting the cash article and possible discrepancies (variances) between despatched and accepted articles, per cash deposit.

#### Cash Count Report Message Definition

The Cash Count Report message provides information about cash counting per reporting criteria, e.g. single count, multi count, etc.

#### Cash Count Statistic Report Message Definition

The Cash Count Statistic Report message provides statistics information about cash counting per reporting criteria, e.g. runtime statistics, deposit statistics, etc.

#### Cash Packaging Report Message Definition

The Cash Count Report message provides information about cash packaging system activities.

## 1.2 References

Reference Name	Description
Cash Processing Machines Communication (GS1, 2017)	The document describes the business process and data requirements to create the set of reporting messages for Cash Processing Machines
BMS Shared Common Library 3.6	Provides the shared common artefacts
BMS eCom Common Library 3.6	Provides the eCom common artefacts

# 2 Business Context

Context category	Value(s)
Industry	Cash Logistics
Geopolitical	All
Product	Cash articles
Process	Deliver / Cash Logistics
System capabilities	GS1 System
Official constraints	None

### 3 Business Transaction View

#### Business scenario general overview

The process under consideration focuses on deposit processing with online interfaces for EDI communication between

- processing systems for banknotes/coins
- packaging systems for banknotes/coins wrapping machines and linked vault management system.

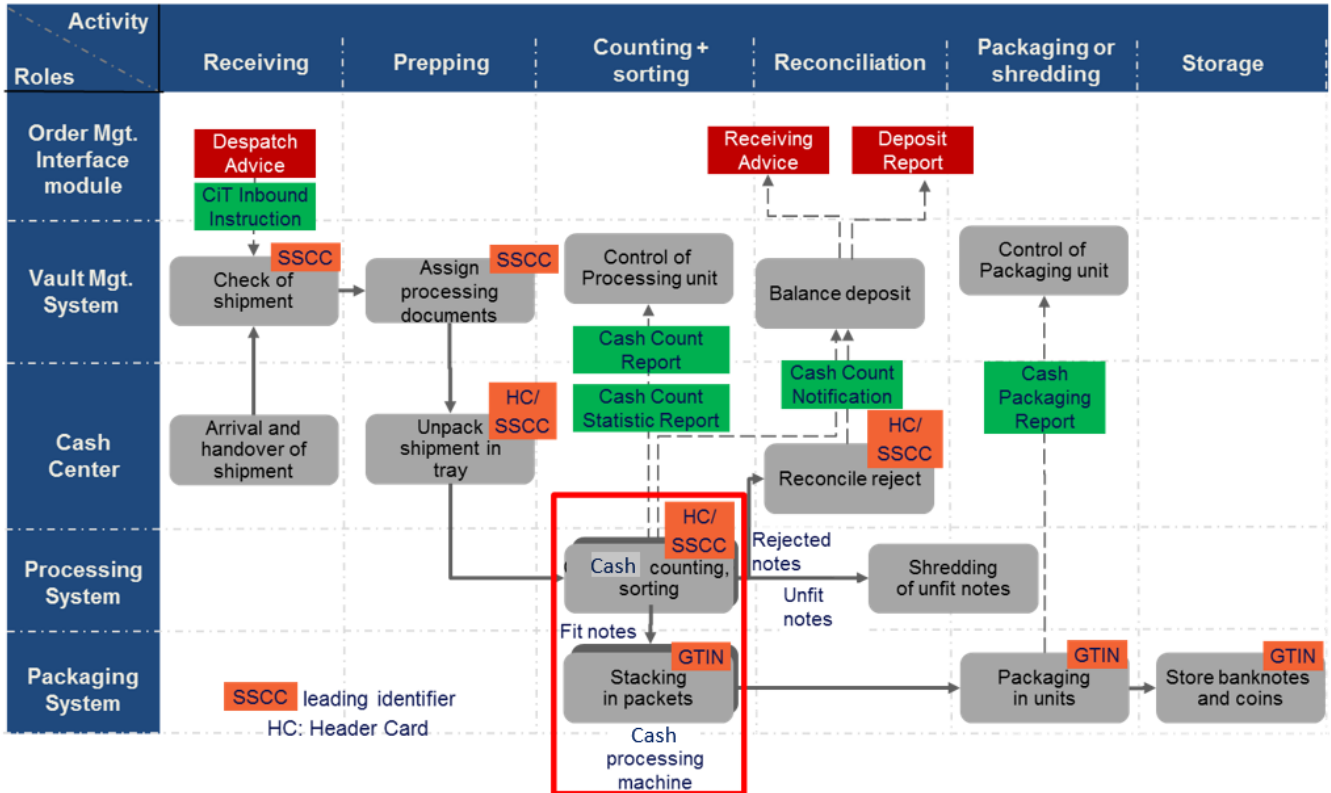

The Processing System workstations send notifications about the cash counting results and statistics information to the Vault Management System of the Cash Centre.

The Processing System workstations send report about cash packaging process to the Vault Management System of the Cash Centre.

### 3.1 Business Transaction - counting, sorting and stacking of cash

#### Use Case Diagram

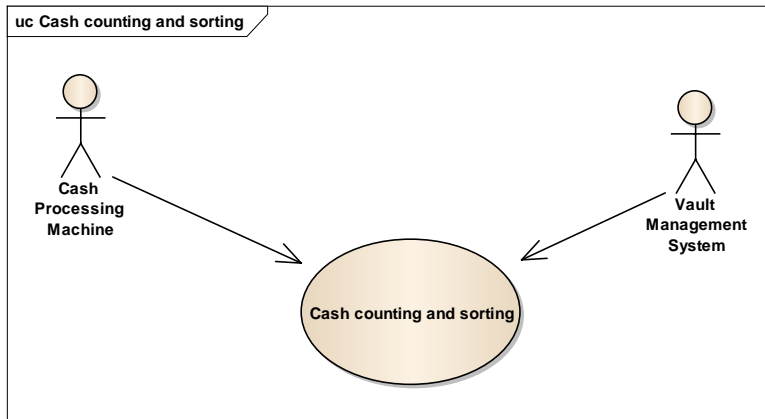

#### Use Case Description

Use case ID	UC-1												
Use case name	Cash counting and sorting												
Use case description	<p>Cash (banknotes and/or coins) deposit is fed into the automated processing systems for singling, verification, counting per piece and optional fitness sorting.</p> <p>Verified (genuine) cash articles are stacked in packets and separated per denomination, fit or unfit or rejected category. If case cash processing machine is equipped with shredding unit, the unfit banknotes are destroyed automatically.</p> <p>The machine reports the processing results and statistics to VMS/SM in classified EDI messages depending on content and trigger.</p>												
Actors (Goal)	Cash Processing Machine (CPM) Vault Management System (VMS)												
Performance goals													
Preconditions	Cash deposit has been delivered to the Cash Centre												
Post conditions	VMS received cash count information from CPM												
Scenario	<p>Begins when... cash articles are fed into the CPM.</p> <p>Continues with...</p> <table border="1" data-bbox="454 1429 1412 1758"> <thead> <tr> <th>Step #</th> <th>Actor</th> <th>Activity step</th> </tr> </thead> <tbody> <tr> <td>1</td> <td>CPM</td> <td>Sends Cash Count Notification of accepted currency per deposit</td> </tr> <tr> <td>2</td> <td>CPM</td> <td>Sends Cash Count Report about processed currency per machine in a defined reporting period, e.g. mainly per shift or day</td> </tr> <tr> <td>3</td> <td>CPM</td> <td>Sends Cash Count Statistic Report with statistics parameters, e.g. runtime, reject reasons per machine in a defined reporting period, e.g. mainly per shift or day</td> </tr> </tbody> </table> <p>Ends when... VMS has received cash count, sorting and (optionally) shredding information.</p>	Step #	Actor	Activity step	1	CPM	Sends Cash Count Notification of accepted currency per deposit	2	CPM	Sends Cash Count Report about processed currency per machine in a defined reporting period, e.g. mainly per shift or day	3	CPM	Sends Cash Count Statistic Report with statistics parameters, e.g. runtime, reject reasons per machine in a defined reporting period, e.g. mainly per shift or day
Step #	Actor	Activity step											
1	CPM	Sends Cash Count Notification of accepted currency per deposit											
2	CPM	Sends Cash Count Report about processed currency per machine in a defined reporting period, e.g. mainly per shift or day											
3	CPM	Sends Cash Count Statistic Report with statistics parameters, e.g. runtime, reject reasons per machine in a defined reporting period, e.g. mainly per shift or day											
Alternative scenario													
Related requirements	Not applicable												
Related rules	Not applicable												



### 3.2 Business Transaction - packing of cash

#### Use Case Diagram

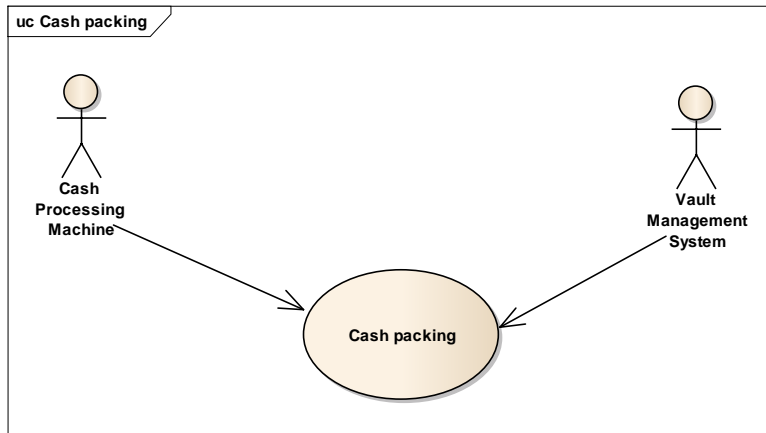

#### Use Case Description

Use case ID	UC-2									
Use case name	Cash packing									
Use case description	Cash articles are packed in different units for storage. Packaging systems can be connected with multiple cash processing machines via conveyors to pack smaller packaging type units into next bigger units. The packaging system can be fed also manually. Several levels of cash packing may be applied, e.g. from packets to bundle, from bundles to cardboard box, from cardboard boxes to container or pallet.									
Actors (Goal)	Cash Processing Machine (CHM) Vault Management System (VMS)									
Performance goals										
Preconditions	Cash deposit has been counted and sorted by CPM									
Post conditions	VMS received cash packing information from CPM									
Scenario	<p>Begins when... cash articles are fed into the packaging unit of CPM.</p> <p>Continues with...</p> <table border="1" data-bbox="454 1384 1412 1568"> <thead> <tr> <th>Step #</th> <th>Actor</th> <th>Activity step</th> </tr> </thead> <tbody> <tr> <td>1</td> <td>Packaging System</td> <td>Packs cash articles in pre-defined units per denomination</td> </tr> <tr> <td>2</td> <td>Packaging System</td> <td>Sends Cash Packaging Report</td> </tr> </tbody> </table> <p>Ends when... VMS has received Cash Packaging Report</p>	Step #	Actor	Activity step	1	Packaging System	Packs cash articles in pre-defined units per denomination	2	Packaging System	Sends Cash Packaging Report
Step #	Actor	Activity step								
1	Packaging System	Packs cash articles in pre-defined units per denomination								
2	Packaging System	Sends Cash Packaging Report								
Alternative scenario										
Related requirements	Not applicable									
Related rules	Not applicable									

#### Activity Diagram(s)

Not Applicable

#### Business Transaction Sequence Diagram(s)

Not Applicable

## 4 Business Information View

### 4.1 Cash Count Notification

#### Class diagram

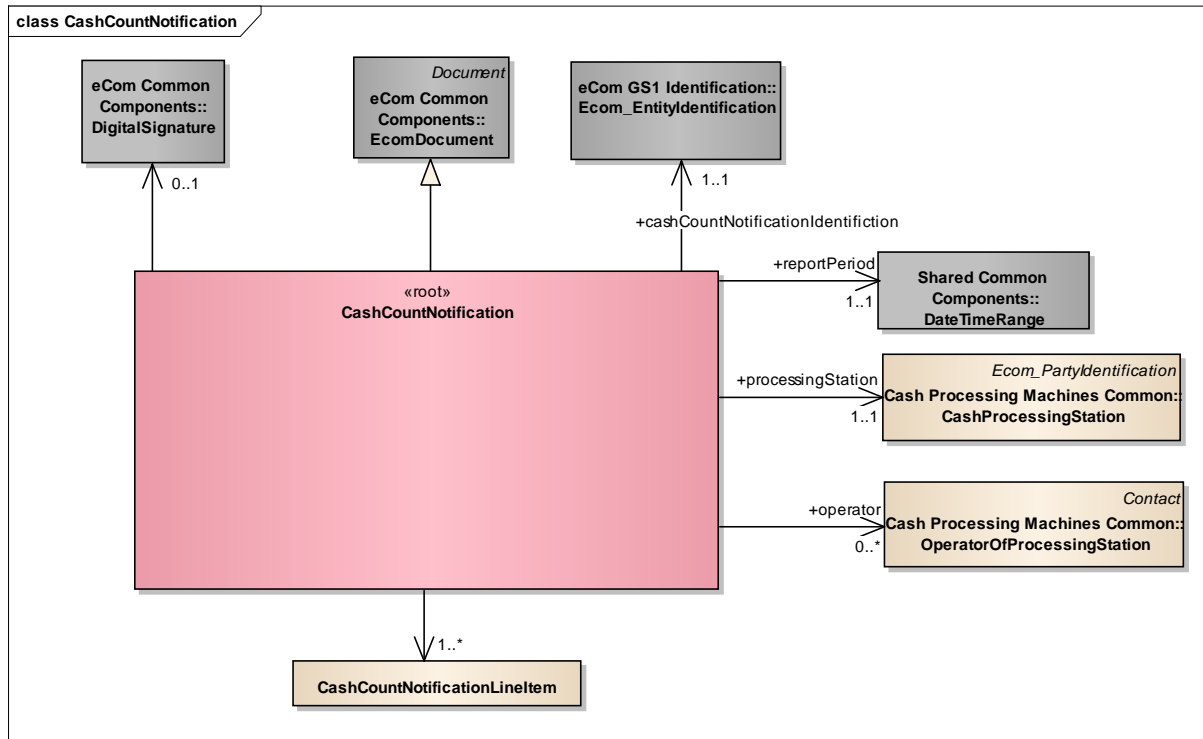

#### GDD report

The content of the CashCountNotification class, its structure and component definitions can be accessed in the Global Data Dictionary: [http://apps.gs1.org/GDD/bms/Version3\\_4/Pages/bieDetails.aspx?semanticURN=urn:gs1:gdd:bie:CashCountNotification](http://apps.gs1.org/GDD/bms/Version3_4/Pages/bieDetails.aspx?semanticURN=urn:gs1:gdd:bie:CashCountNotification)



## Cash Processing Business Message Standard (BMS)

Content	Attribute / Role	Datatype / Secondaryclass	Multiplicity	Definition	Requirements
CashCountNotification				Message reporting the results of counting the cash article and possible discrepancies (variances) between despatched and accepted articles, per cash deposit.	WR 16-000428
Generalization		EcomDocument		Basic information about the content of the message including version number, creation date and time and the placeholder for non-standard attributes.	
Association	reportPeriod	DateTimeRange	1..1	Provides the start and finish of the reporting period for which the Cash Count Notification is being sent.	
Association	processingStation	CashProcessingStation	1..1	Person, Machine or place where the cash is processed (e.g. Cash Processing Machine, Workstation, Cash Centre ...)	
Association	operator	OperatorOfProcessingStation	0..*	Provides identification and contact information of responsible persons during the cash processing. E.g. Quality Coordinator.	
Association	cashCountNotificationIdentification	Ecom_EntityIdentification	1..1	Provides the identification of the Cash Count Notification.	
Association		DigitalSignature	0..1	Digital signature for signing the message.	
Association		CashCountNotificationLineItem	1..*	Provides detailed information about currency counting results.	



**Note:** Reference Shared Common Library Business Message (BMS) Release 3.6 and eCom Domain Common Library Business Message (BMS) Release 3.6 for all common information.

### 4.1.1 Cash Count Notification Line Item

#### Class diagram

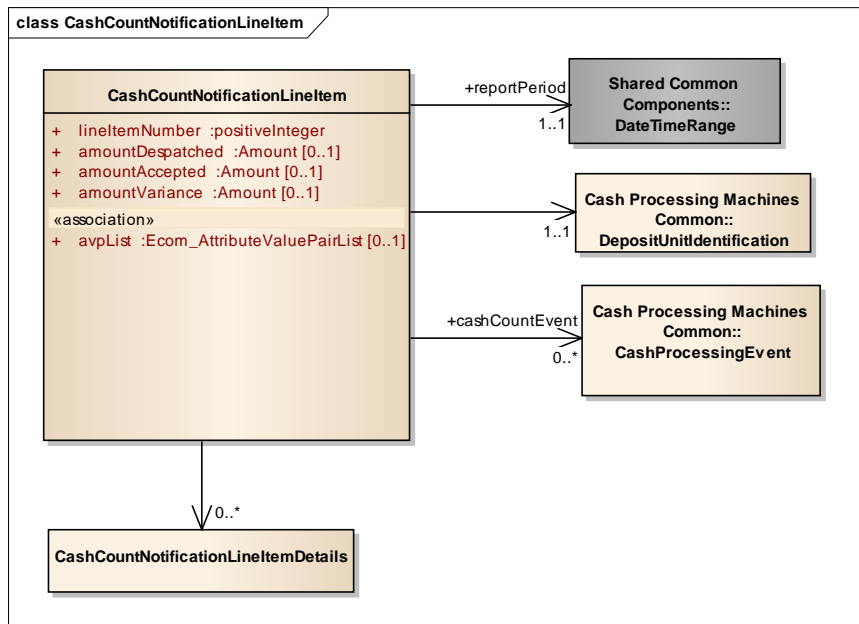

#### GDD report

The content of the CashCountNotificationLineItem class, its structure and component definitions can be accessed in the Global Data Dictionary: [http://apps.gs1.org/GDD/bms/Version3\\_4/Pages/bieDetails.aspx?semanticURN=urn:gs1:gdd:bie:CashCountNotificationLineItem](http://apps.gs1.org/GDD/bms/Version3_4/Pages/bieDetails.aspx?semanticURN=urn:gs1:gdd:bie:CashCountNotificationLineItem)

Content	Attribute / Role	Datatype /Secondary class	Multiplicity	Definition	Requirements
CashCountNotificationLineItem				Specifies the information related to each line item. Each CashCountNotification will contain one or more line items.	
Association		CashCountNotificationLineItem Details	0..*	Specifies detailed information per cash article in a deposit unit.	

Content	Attribute / Role	Datatype /Secondary class	Multiplicity	Definition	Requirements
Association	reportPeriod	DateTimeRange	1..1	Specifies the report period of the processed deposit unit.	
Association	cashCountEvent	CashProcessingEvent	0..*	Specifies event that occurred during deposit unit processing.	
Association		DepositUnitIdentification	1..1	Provides details of deposit unit.	
Attribute	lineItemNumber	positiveInteger	1..1	Provides the line number associated to the CashCountNotification Line Item.	
Attribute	amountDespatched	Amount	0..1	Despatched value of deposit/ SSCC, calculated from Despatch Advice.	
Attribute	amountAccepted	Amount	0..1	Accepted - verified amount of each Header Card or SSCC.	
Attribute	amountVariance	Amount	0..1	Variance between despatched (Said to contain) and accepted amount value per Header Card or SSCC.	
Attribute	avpList	Ecom_AttributeValuePairList	0..1	Temporary attributes introduced between minor versions.	

**Note:** Reference Shared Common Library Business Message (BMS) Release 3.6 and eCom Domain Common Library Business Message (BMS) Release 3.6 for all common information.

### 4.1.2 Cash Count Notification Line Item Details

#### Class diagram

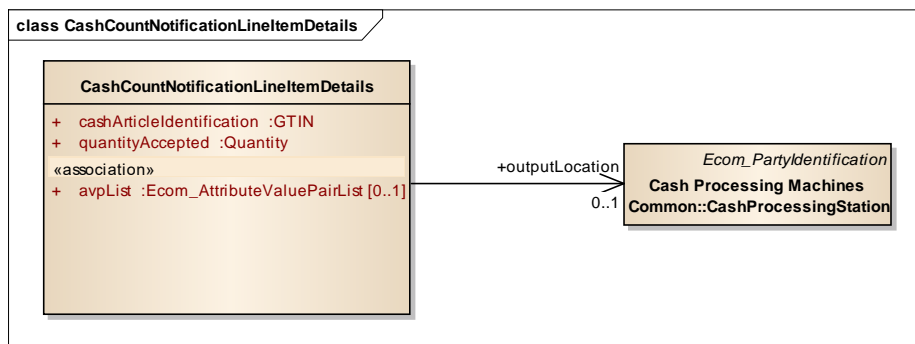

**GDD report**

The content of the CashCountNotificationLineItemDetails class, its structure and component definitions can be accessed in the Global Data Dictionary:

[http://apps.gs1.org/GDD/bms/Version3\\_4/Pages/bieDetails.aspx?semanticURN=urn:gs1:gdd:bie:CashCountNotificationLineItemDetails](http://apps.gs1.org/GDD/bms/Version3_4/Pages/bieDetails.aspx?semanticURN=urn:gs1:gdd:bie:CashCountNotificationLineItemDetails)

Content	Attribute / Role	Datatype / Secondaryclass	Multiplicity	Definition	Requirements
CashCountNotificationLineItemDetails				Specifies detailed information per cash article in a deposit unit.	
Attribute	cashArticleIdentification	GTIN	1..1	Identifies cash article being processed. Note: In Eurosystem a.k.a. euro zone The GTINs are assigned to cash articles by the European Central Bank. For other currencies, the local Central Banks need to create the GTIN list assigned to respective cash articles.	
Association	outputLocation	CashProcessingStation	0..1	Identifies the output stacker in the processing station. NOTE: The output stacker should be identified by the GLN, but if it is not assigned, an additional identification can be provided.	
Attribute	quantityAccepted	Quantity	1..1	Specifies accepted quantity of a given cash article.	
Attribute	avpList	Ecom_AttributeValuePairList	0..1	Temporary attributes introduced between minor versions.	



**Note:** Reference Shared Common Library Business Message (BMS) Release 3.6 and eCom Domain Common Library Business Message (BMS) Release 3.6 for all common information.

## 4.2 Cash Count Report

### Class diagram

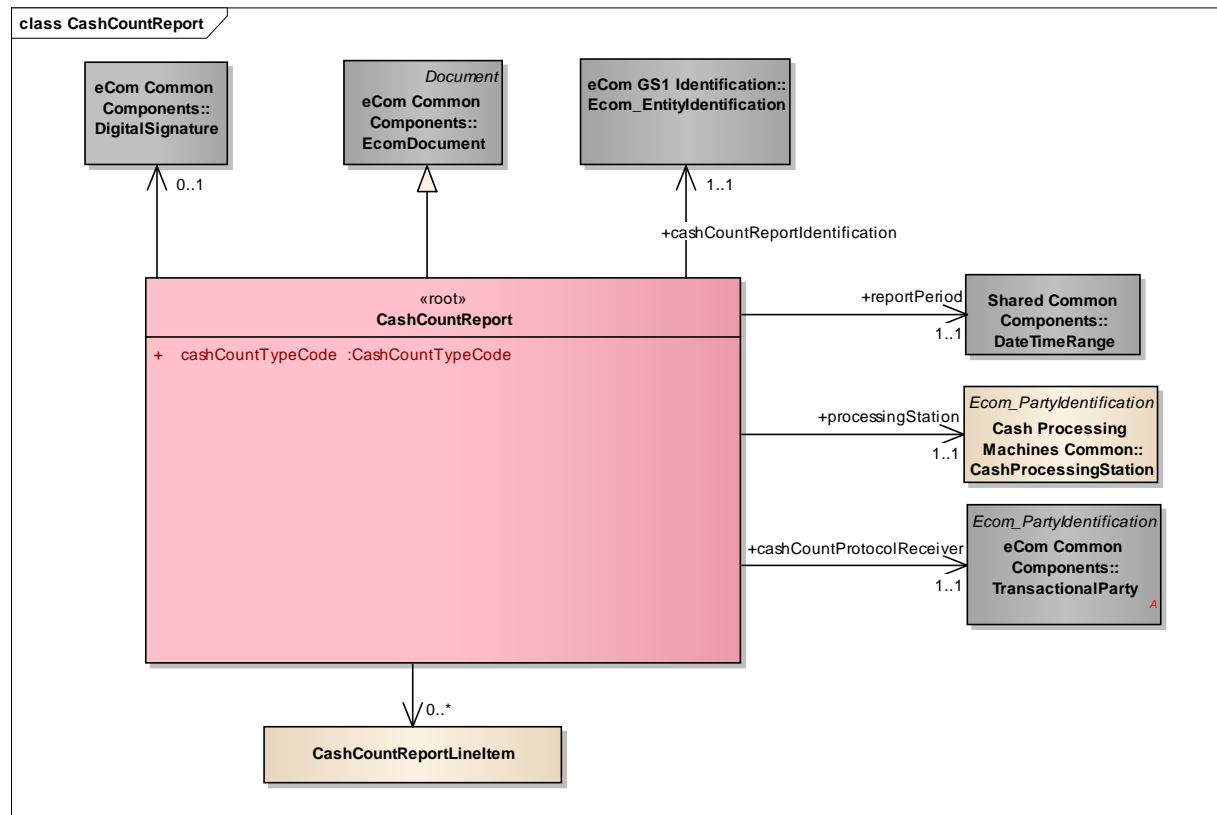

### GDD report

The content of the CashCountReport class, its structure and component definitions can be accessed in the Global Data Dictionary:  
[http://apps.gs1.org/GDD/bms/Version3\\_4/Pages/bieDetails.aspx?semanticURN=urn:gs1:gdd:bie:CashCountReport](http://apps.gs1.org/GDD/bms/Version3_4/Pages/bieDetails.aspx?semanticURN=urn:gs1:gdd:bie:CashCountReport)



Cash Processing Business Message Standard (BMS)

Content	Attribute / Role	Datatype / Secondaryclass	Multiplicity	Definition	Requirements
CashCountReport				The Cash Count Report message provides information about cash counting per reporting criteria, e.g. single count, multi count, etc.	WR 16-000428
Generalization		EcomDocument		Basic information about the content of the message including version number, creation date and time and the placeholder for non-standard attributes.	
Association	reportPeriod	DateTimeRange	1..1	Provides the start and finish of the reporting period.	
Association		CashCountReportLineItem	0..*	Provides detailed information about currency counting results.	
Association	cashCountReportIdentification	Ecom_EntityIdentification	1..1	Provides the identification of the Cash Count Report.	
Association		DigitalSignature	0..1	Digital signature for signing the message.	
Association	processingStation	CashProcessingStation	1..1	Information about the cash processor. This can be for instance a cash processing machine, a manual operated workstation or a back office system.	
Association	cashCountProtocolReceiver	TransactionalParty	1..1	Identification of receiver for Cash Count protocol.	
Attribute	cashCountTypeCode	CashCountTypeCode	1..1	Type of cash processing, e.g. single count, multi count, shredding.	



**Note:** Reference Shared Common Library Business Message (BMS) Release 3.6 and eCom Domain Common Library Business Message (BMS) Release 3.6 for all common information.



## 4.2.1 Cash Count Report Line Item

### Class diagram

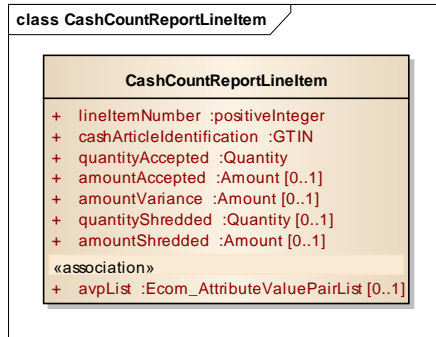

### GDD report

The content of the CashCountReportLineItem class, its structure and component definitions can be accessed in the Global Data Dictionary:  
[http://apps.gs1.org/GDD/bms/Version3\\_4/Pages/bieDetails.aspx?semanticURN=urn:gs1:gdd:bie:CashCountReportLineItem](http://apps.gs1.org/GDD/bms/Version3_4/Pages/bieDetails.aspx?semanticURN=urn:gs1:gdd:bie:CashCountReportLineItem)

Content	Attribute / Role	Datatype /Secondary class	Multiplicity	Definition	Requirements
CashCountReportLineItem				Provides detailed information about currency counting results.	
Attribute	lineItemNumber	positiveInteger	1..1	Identification of the line item.	
Attribute	cashArticleIdentification	GTIN	1..1	Identification of the verified banknote or coin article by GTIN. NOTE: In Eurosystem a.k.a. euro zone The GTINs are assigned to cash articles by the European Central Bank. For other currencies, the local Central Banks need to create the GTIN list assigned to respective cash articles.	
Attribute	quantityAccepted	Quantity	1..1	Quantity of accepted cash articles.	
Attribute	amountAccepted	Amount	0..1	The total amount (monetary value) of the accepted cash articles per GTIN.	
Attribute	amountVariance	Amount	0..1	Variance between despatched (Said to contain) and accepted amount value per Header Card or SSCC.	



Cash Processing Business Message Standard (BMS)

Content	Attribute / Role	Datatype /Secondary class	Multiplicity	Definition	Requirements
Attribute	quantityShredded	Quantity	0..1	Quantity of shredded / destroyed cash articles per GTIN NOTE: If there is no GTIN for shredded banknotes used, the information is always mandatory.	
Attribute	amountShredded	Amount	0..1	The total amount (monetary value) of the shredded / destroyed cash articles per GTIN.	
Attribute	avpList	Ecom_AttributeValuePairList	0..1	Temporary attributes introduced between minor versions.	



**Note:** Reference Shared Common Library Business Message (BMS) Release 3.6 and eCom Domain Common Library Business Message (BMS) Release 3.6 for all common information.

### 4.3 Cash Count Statistic Report

#### Class diagram

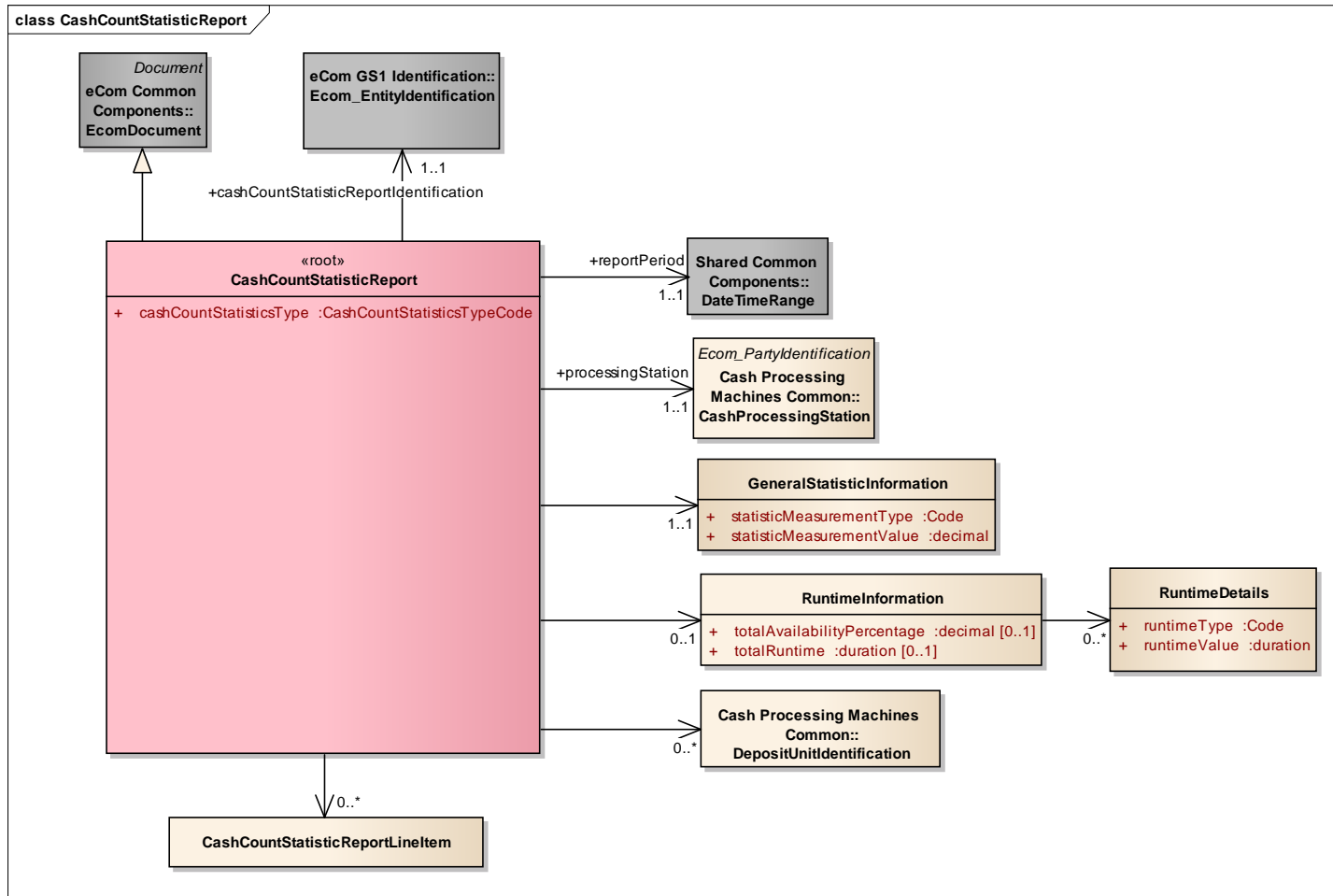

**GDD report**

The content of the CashCountStatisticReport class, its structure and component definitions can be accessed in the Global Data Dictionary: [http://apps.gs1.org/GDD/bms/Version3\\_4/Pages/bieDetails.aspx?semanticURN=urn:gs1:gdd:bie:CashCountStatisticReport](http://apps.gs1.org/GDD/bms/Version3_4/Pages/bieDetails.aspx?semanticURN=urn:gs1:gdd:bie:CashCountStatisticReport)

Content	Attribute / Role	Datatype /Secondary class	Multiplicity	Definition	Requirements
CashCountStatisticReport				The Cash Count Statistic Report message provides statistics information about cash counting per reporting criteria, e.g. runtime statistics, deposit statistics, etc.	WR 16-000428
Generalization		EcomDocument		Basic information about the content of the message including version number, creation date and time and the placeholder for non-standard attributes.	
Association	reportPeriod	DateTimeRange	1..1	Provides the start and finish of the reporting period.	
Association	processingStation	CashProcessingStation	1..1	Information about the cash processor. This can be for instance a cash processing machine, a manual operated workstation or a back office system.	
Association		RuntimeInformation	0..1	Information about different periods of time while the machine was running.	
Association		GeneralStatisticInformation	1..1	Specifies the value of statistic measurement.	
Association	cashCountStatisticReportIdentification	Ecom_EntityIdentification	1..1	Identification of the Cash Count Statistic Report Identification.	
Association		DepositUnitIdentification	0..*	Provides details of deposit unit.	
Association		CashCountStatisticReportLineItem	0..*	Provides detailed information about currency counting results.	
Attribute	cashCountStatisticsType	CashCountStatisticsTypeCode	1..1	Type of statistics related to cash processing.	
GeneralStatisticInformation				General statistic information, such as number of deposits processed.	
Attribute	statisticMeasurementType	Code	1..1	Specifies the type of statistic measurement e.g. number of deposits processed.	



Content	Attribute / Role	Datatype /Secondary class	Multiplicity	Definition	Requirements
Attribute	statisticMeasurementValue	decimal	1..1	Specifies the value of statistic measurement.	
RuntimeInformation				Information about different periods of time while the machine was running.	
Association		RuntimeDetails	0..*	Provides details of each runtime: type and duration.	
Attribute	totalAvailabilityPercentage	decimal	0..1	Information about the total availability while the machine was running.	
Attribute	totalRuntime	duration	0..1	Total runtime from power on until power off.	
RuntimeDetails				Provides details of each runtime: type and duration.	
Attribute	runtimeType	Code	1..1	Specifies the type of runtime event, e.g. Power-up.	
Attribute	runtimeValue	duration	1..1	Duration of the runtime event type.	



**Note:** Reference Shared Common Library Business Message (BMS) Release 3.6 and eCom Domain Common Library Business Message (BMS) Release 3.6 for all common information.

### 4.3.1 Cash Count Statistic Report Line Item

#### Class diagram

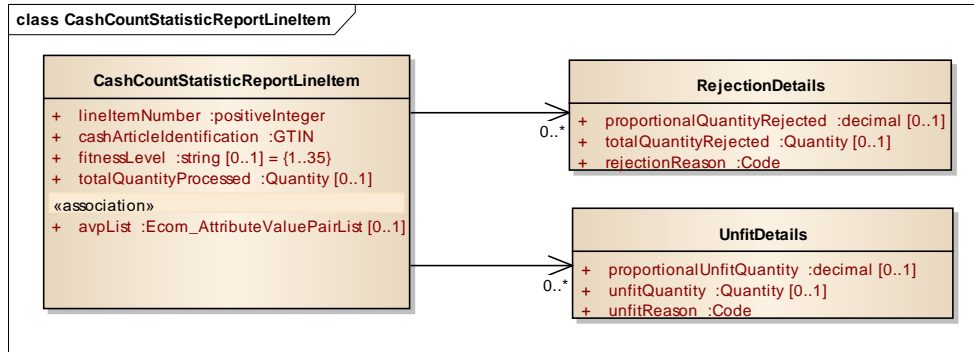

#### GDD report

The content of the CashCountStatisticReportLineItem class, its structure and component definitions can be accessed in the Global Data Dictionary:

[http://apps.gs1.org/GDD/bms/Version3\\_4/Pages/bieDetails.aspx?semanticURN=urn:gs1:gdd:bie:CashCountStatisticReportLineItem](http://apps.gs1.org/GDD/bms/Version3_4/Pages/bieDetails.aspx?semanticURN=urn:gs1:gdd:bie:CashCountStatisticReportLineItem)

Content	Attribute / Role	Datatype /Secondary class	Multiplicity	Definition	Requirements
CashCountStatisticReportLineItem				Provides detailed information about currency counting results.	
Attribute	lineItemNumber	positiveInteger	1..1	Identification of the line item.	
Attribute	cashArticleIdentification	GTIN	1..1	Identification of the verified banknote or coin article by GTIN. NOTE: In Eurosystem a.k.a. euro zone The GTINs are assigned to cash articles by the European Central Bank. For other currencies, the local Central Banks need to create the GTIN list assigned to respective cash articles.	
Attribute	fitnessLevel	string	0..1	The fitness level thresholds are defined by the operation and configuration mode of the system.	



Content	Attribute / Role	Datatype /Secondary class	Multiplicity	Definition	Requirements
Attribute	totalQuantityProcessed	Quantity	0..1	Quantity of processed cash articles per cash article (GTIN).	
Association		RejectionDetails	0..*	Provides details about rejected cash articles.	
Association		UnfitDetails	0..*	Provides details about unfit cash articles.	
Attribute	avpList	Ecom_AttributeValuePairList	0..1	Temporary attributes introduced between minor versions.	
RejectionDetails				Provides details about rejected cash articles.	
Attribute	proportionalQuantityRejected	decimal	0..1	Percentage of rejected notes in all processed ones per GTIN.	
Attribute	rejectionReason	Code	1..1	List of reason for cash articles rejection, e.g. missing watermark	
Attribute	totalQuantityRejected	Quantity	0..1	Quantity of cash articles rejected during processing per GTIN.	
UnfitDetails				Provides details about unfit cash articles.	
Attribute	proportionalUnfitQuantity	decimal	0..1	Percentage of unfit group in relation to processed banknotes / coins.	
Attribute	unfitQuantity	Quantity	0..1	Quantity of unfit cash articles per GTIN (units).	
Attribute	unfitReason	Code	1..1	List of reason for cash articles unfitness, e.g. missing edge in upper left corner.	



**Note:** Reference Shared Common Library Business Message (BMS) Release 3.6 and eCom Domain Common Library Business Message (BMS) Release 3.6 for all common information.

## 4.4 Cash Packaging Report

### Class diagram

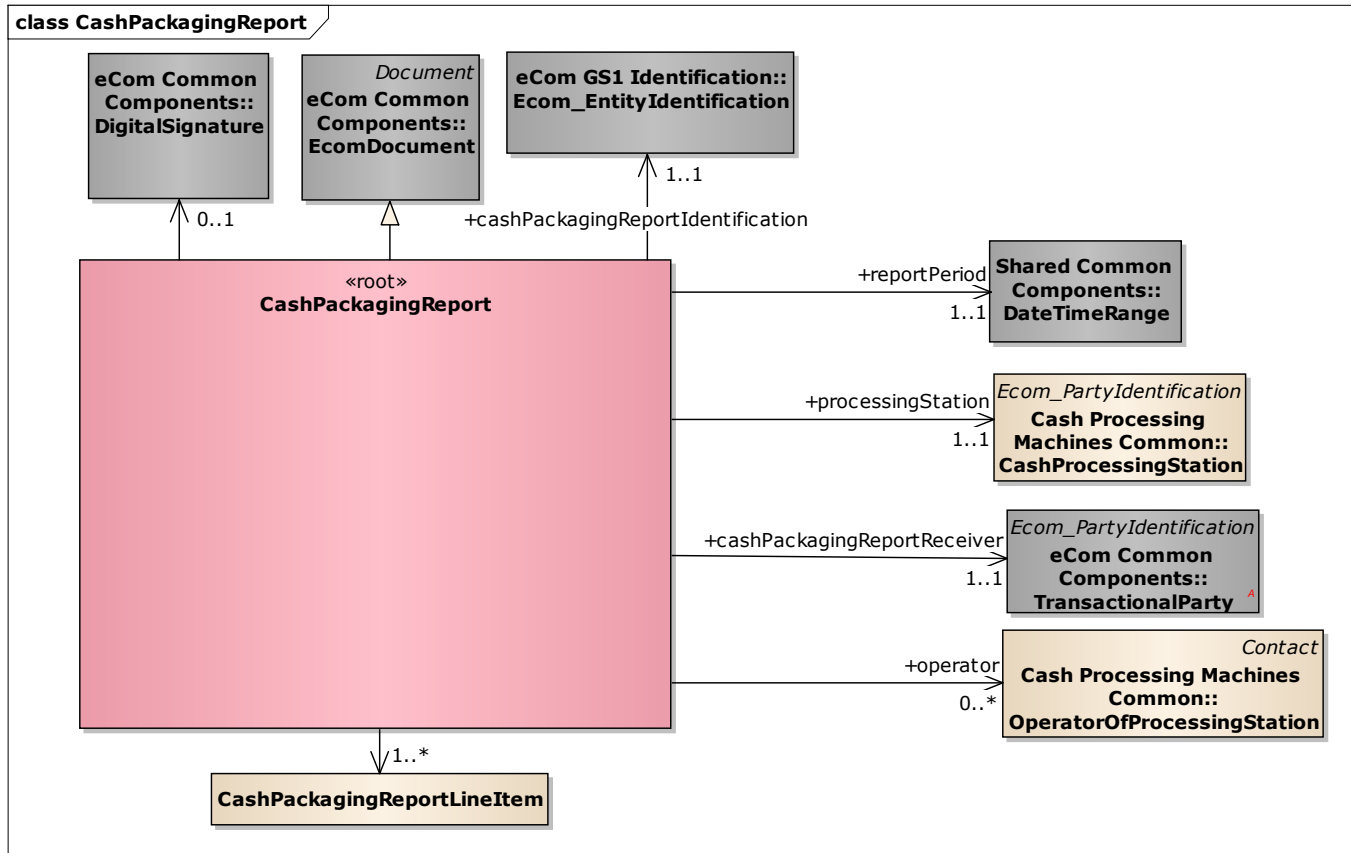

### GDD report

The content of the CashPackagingReport class, its structure and component definitions can be accessed in the Global Data Dictionary:  
[http://apps.gs1.org/GDD/bms/Version3\\_4/Pages/bieDetails.aspx?semanticURN=urn:gs1:gdd:bie:CashPackagingReport](http://apps.gs1.org/GDD/bms/Version3_4/Pages/bieDetails.aspx?semanticURN=urn:gs1:gdd:bie:CashPackagingReport)





## Cash Processing Business Message Standard (BMS)

Content	Attribute / Role	Datatype /Secondary class	Multiplicity	Definition	Requirements
CashPackagingReport				The Cash Count Report message provides information about cash packaging system activities.	
Generalization		EcomDocument		Basic information about the content of the message including version number, creation date and time and the placeholder for non-standard attributes.	
Association		CashPackagingReportLineItem	1..*	Provides detailed information about currency packaging process.	
Association	operator	OperatorOfProcessingStation	0..*	Provides identification and contact information of responsible persons during the cash processing. E.g. Quality coordinator contact.	
Association	reportPeriod	DateTimeRange	1..1	Provides the start and finish of the reporting period.	
Association		DigitalSignature	0..1	Digital signature for signing the message.	
Association	cashPackagingReportReceiver	TransactionalParty	1..1	Identification of the receiver of the packaging report protocol.	
Association	processingStation	CashProcessingStation	1..1	Person, Machine or place where the cash is processed (e.g. packaging system, a manual operated workstation or a back office system...).	
Association	cashPackagingReportIdentification	Ecom_EntityIdentification	1..1	Identification of the Cash Packaging Report.	



**Note:** Reference Shared Common Library Business Message (BMS) Release 3.6 and eCom Domain Common Library Business Message (BMS) Release 3.6 for all common information.

### 4.4.1 Cash Packaging Report Line Item

#### Class diagram

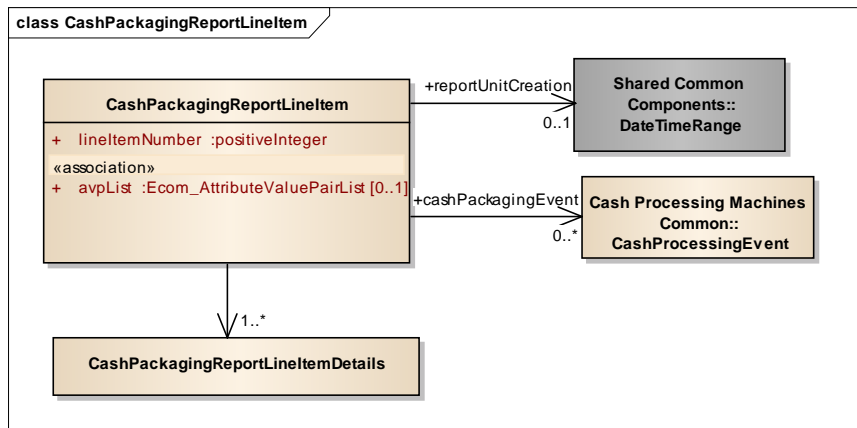

#### GDD report

The content of the `CashPackagingReportLineItem` class, its structure and component definitions can be accessed in the Global Data Dictionary: [http://apps.gs1.org/GDD/bms/Version3\\_4/Pages/bieDetails.aspx?semanticURN=urn:gs1:gdd:bie:CashPackagingReportLineItem](http://apps.gs1.org/GDD/bms/Version3_4/Pages/bieDetails.aspx?semanticURN=urn:gs1:gdd:bie:CashPackagingReportLineItem)

Content	Attribute / Role	Datatype /Secondary class	Multiplicity	Definition	Requirements
CashPackagingReportLineItem				Provides detailed information about currency packaging process.	
Association	reportUnitCreation	DateTimeRange	0..1	Provides the start and finish of the creation of the reported unit, for individual packaging level.	
Association		CashPackagingReportLineItemDetails	1..*	Detailed information on processed currencies.	
Association	cashPackagingEvent	CashProcessingEvent	0..*	Specifies event that occurred during cash packaging.	
Attribute	lineItemNumber	positiveInteger	1..1	Identification of the line item.	



Cash Processing Business Message Standard (BMS)

Content	Attribute / Role	Datatype /Secondary class	Multiplicity	Definition	Requirements
Attribute	avpList	Ecom_AttributeValuePairList	0..1	Temporary attributes introduced between minor versions.	



**Note:** Reference Shared Common Library Business Message (BMS) Release 3.6 and eCom Domain Common Library Business Message (BMS) Release 3.6 for all common information.

## 4.4.2 Cash Packaging Report Line Item Details

### Class diagram

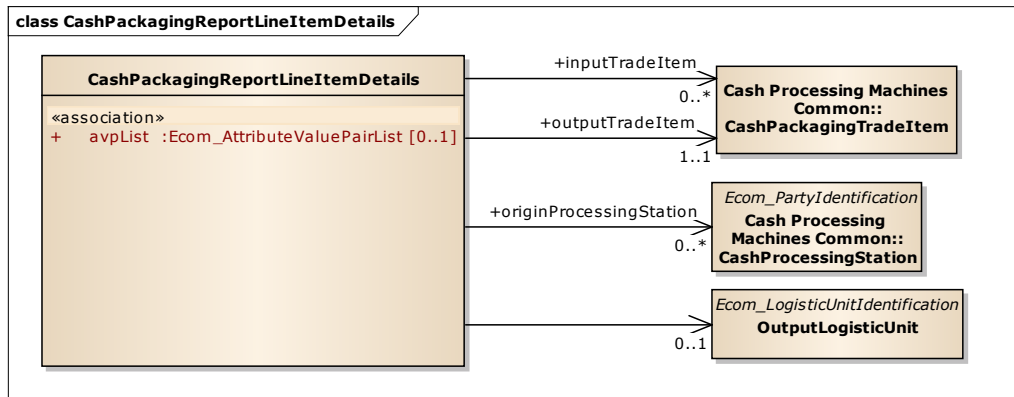

### GDD report

The content of the **CashPackagingReportLineItemDetails** class, its structure and component definitions can be accessed in the Global Data Dictionary:

[http://apps.gs1.org/GDD/bms/Version3\\_4/Pages/bieDetails.aspx?semanticURN=urn:gs1:gdd:bie:CashPackagingReportLineItemDetails](http://apps.gs1.org/GDD/bms/Version3_4/Pages/bieDetails.aspx?semanticURN=urn:gs1:gdd:bie:CashPackagingReportLineItemDetails)

Content	Attribute / Role	Datatype /Secondary class	Multiplicity	Definition	Requirements
CashPackagingReportLineItem Details				Detailed information on processed currencies.	
Association	outputTradeItem	CashPackagingTradeItem	1..1	Identification of the packed banknote or coin article by GTIN.	
Association	originProcessingStation	CashProcessingStation	0..*	Identification of Cash processing Station that produced the input trade item.	
Association		OutputLogisticUnit	0..1	Identification of logistic unit, in case of "one piece flow" production for individual order with defined cash article.	



Content	Attribute / Role	Datatype /Secondary class	Multiplicity	Definition	Requirements
Association	inputTradeItem	CashPackagingTradeItem	0..*	Identification of the packed banknote or coin article by GTIN.	
Attribute	avpList	Ecom_AttributeValuePairList	0..1	Temporary attributes introduced between minor versions.	



**Note:** Reference Shared Common Library Business Message (BMS) Release 3.6 and eCom Domain Common Library Business Message (BMS) Release 3.6 for all common information.

### 4.4.3 Cash Packaging Report – Output Logistic Unit

#### Class diagram

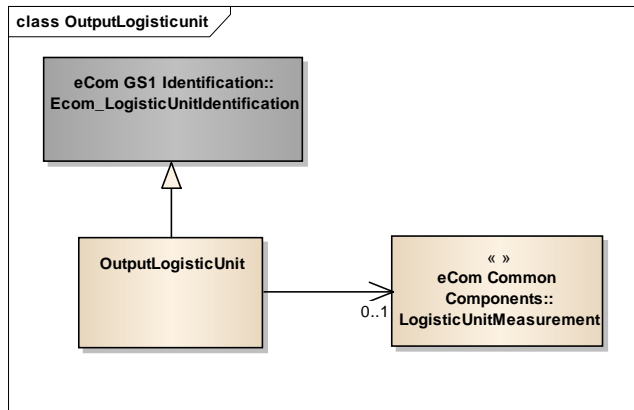

#### GDD report

The content of the OutputLogisticUnit class, its structure and component definitions can be accessed in the Global Data Dictionary:  
[http://apps.gs1.org/GDD/bms/Version3\\_4/Pages/bieDetails.aspx?semanticURN=urn:gs1:gdd:bie:OutputLogisticUnit](http://apps.gs1.org/GDD/bms/Version3_4/Pages/bieDetails.aspx?semanticURN=urn:gs1:gdd:bie:OutputLogisticUnit)

Content	Attribute / Role	Datatype /Secondary class	Multiplicity	Definition	Requirements
OutputLogisticUnit				Identification of logistic unit, in case of "one piece flow" production for individual order with defined cash article.	
Generalization		Ecom_LogisticUnitIdentification		The globally unique identification attached to a shipping container or shipping package and used for logistical and traceability purposes.	
Association		LogisticUnitMeasurement	0..1	Measurement of gross weight or gross volume per logistic unit.	



**Note:** Reference Shared Common Library Business Message (BMS) Release 3.6 and eCom Domain Common Library Business Message (BMS) Release 3.6 for all common information.

## 4.5 Cash Processing Machines Common

### 4.5.1 Cash Processing Machines Common – Cash Processing Event

#### Class diagram

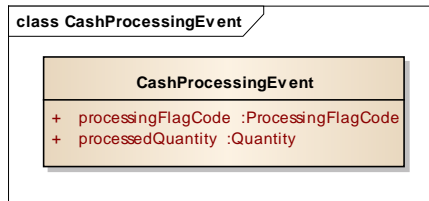

#### GDD report

The content of the CashProcessingEvent class, its structure and component definitions can be accessed in the Global Data Dictionary:  
[http://apps.gs1.org/GDD/bms/Version3\\_4/Pages/bieDetails.aspx?semanticURN=urn:gs1:gdd:bie:CashProcessingEvent](http://apps.gs1.org/GDD/bms/Version3_4/Pages/bieDetails.aspx?semanticURN=urn:gs1:gdd:bie:CashProcessingEvent)

Content	Attribute / Role	Datatype /Secondary class	Multiplicity	Definition	Requirements
CashProcessingEvent				Specifies event that occurred during cash processing.	
Attribute	processingFlagCode	CashProcessingFlagCode	1..1	Specifies the type of event that occurred during cash processing.	
Attribute	processedQuantity	Quantity	1..1	Quantity of cash articles to which the specific processing flag applies.	



**Note:** Reference Shared Common Library Business Message (BMS) Release 3.6 and eCom Domain Common Library Business Message (BMS) Release 3.6 for all common information.

## 4.5.2 Cash Processing Machines Common – Cash Packaging Trade Item

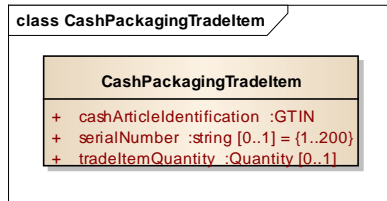

### GDD report

The content of the CashPackagingTradeItem class, its structure and component definitions can be accessed in the Global Data Dictionary: [http://apps.gs1.org/GDD/bms/Version3\\_4/Pages/bieDetails.aspx?semanticURN=urn:gs1:gdd:bie:CashPackagingTradeItem](http://apps.gs1.org/GDD/bms/Version3_4/Pages/bieDetails.aspx?semanticURN=urn:gs1:gdd:bie:CashPackagingTradeItem)

Content	Attribute / Role	Datatype /Secondary class	Multiplicity	Definition	Requirements
CashPackagingTradeItem				Provides the identification and optional serial number of the Cash Packaging Item.	
Attribute	cashArticleIdentification	GTIN	1..1	Identifies cash article being processed. NOTE: In Eurosystem a.k.a. euro zone The GTINs are assigned to cash articles by the European Central Bank. For other currencies, the local Central Banks need to create the GTIN list assigned to respective cash articles.	
Attribute	serialNumber	string	0..1	A unique identifier assigned to a specific trade item.	
Attribute	tradeItemQuantity	Quantity	0..1	The total number of individual trade items being specified.	



**Note:** Reference Shared Common Library Business Message (BMS) Release 3.6 and eCom Domain Common Library Business Message (BMS) Release 3.6 for all common information.



### 4.5.3 Cash Processing Machines Common – Cash Processing Station

#### Class diagram

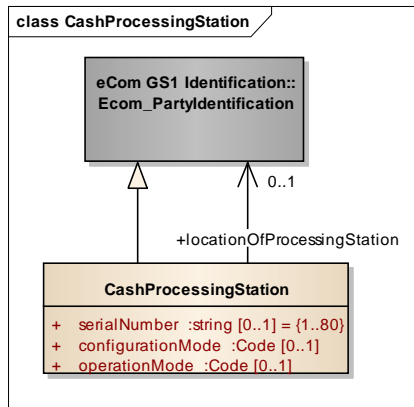

#### GDD report

The content of the CashProcessingStation class, its structure and component definitions can be accessed in the Global Data Dictionary:  
[http://apps.gs1.org/GDD/bms/Version3\\_4/Pages/bieDetails.aspx?semanticURN=urn:gs1:gdd:bie:CashProcessingStation](http://apps.gs1.org/GDD/bms/Version3_4/Pages/bieDetails.aspx?semanticURN=urn:gs1:gdd:bie:CashProcessingStation)

Content	Attribute / Role	Datatype /Secondary class	Multiplicity	Definition	Requirements
CashProcessingStation				Information about the cash processor. This can be for instance a cash handling machine, a manual operated workstation or a back office system.	
Association	locationOfProcessingStation	Ecom_PartyIdentification	0..1	Location of the processing station in the Cash Centre.	
Generalization		Ecom_PartyIdentification		Information used to identify a party or location.	
Attribute	serialNumber	string	0..1	A unique identifier assigned to a specific Processing Station.	
Attribute	configurationMode	Code	0..1	Type of cash processing machine configuration, e.g. stacker configuration.	



Content	Attribute / Role	Datatype /Secondary class	Multiplicity	Definition	Requirements
Attribute	operationMode	Code	0..1	Type of operation mode during processing, e. g. online-counting, offline/header card counting, shredding.	



**Note:** Reference Shared Common Library Business Message (BMS) Release 3.6 and eCom Domain Common Library Business Message (BMS) Release 3.6 for all common information.

#### 4.5.4 Cash Processing Machines Common – Deposit Unit Identification

##### Class diagram

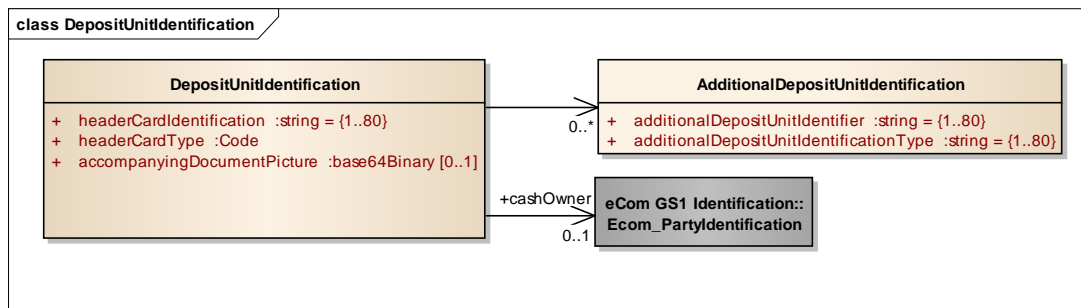

##### GDD report

The content of the DepositUnitIdentification class, its structure and component definitions can be accessed in the Global Data Dictionary: [http://apps.gs1.org/GDD/bms/Version3\\_4/Pages/bieDetails.aspx?semanticURN=urn:gs1:gdd:bie:DepositUnitIdentification](http://apps.gs1.org/GDD/bms/Version3_4/Pages/bieDetails.aspx?semanticURN=urn:gs1:gdd:bie:DepositUnitIdentification)

Content	Attribute / Role	Datatype /Secondary class	Multiplicity	Definition	Requirements
DepositUnitIdentification				Provides details of deposit unit.	
Association	cashOwner	Ecom_PartyIdentification	0..1	Submitter / owner of the cash being processed.	
Association		AdditionalDepositUnitIdentification	0..*	Additional identification of the Deposit Unit.	

Content	Attribute / Role	Datatype /Secondary class	Multiplicity	Definition	Requirements
Attribute	headerCardIdentification	string	1..1	Unique identifier of the Header Card. NOTE: If header card is not used, the ID should be filled up with "0".	
Attribute	headerCardType	Code	1..1	Type of the header card.	
Attribute	accompanyingDocumentPicture	base64Binary	0..1	Picture (photo) of the banknote straps in case of bundle count or other document accompanying a deposit slip.	
AdditionalDepositUnitIdentification				Additional identification of the Deposit Unit.	
Attribute	additionalDepositUnitIdentifier	string	1..1	Additional identifier of the deposit unit, e.g. SSCC	
Attribute	additionalDepositUnitIdentificationType	string	1..1	Specifies the type of additional deposit unit identification.	



**Note:** Reference Shared Common Library Business Message (BMS) Release 3.6 and eCom Domain Common Library Business Message (BMS) Release 3.6 for all common information.

#### 4.5.5 Cash Processing Machines Common – Operator of Processing Station

##### Class diagram

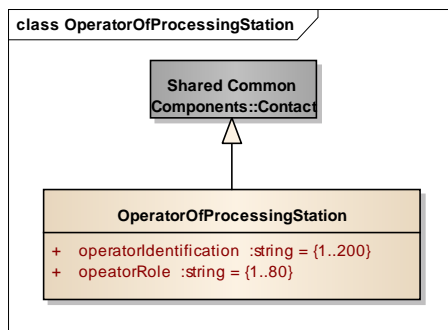

##### GDD report

The content of the OperatorOfProcessingStation class, its structure and component definitions can be accessed in the Global Data Dictionary: [http://apps.gs1.org/GDD/bms/Version3\\_4/Pages/bieDetails.aspx?semanticURN=urn:gs1:gdd:bie:OperatorOfProcessingStation](http://apps.gs1.org/GDD/bms/Version3_4/Pages/bieDetails.aspx?semanticURN=urn:gs1:gdd:bie:OperatorOfProcessingStation)



Content	Attribute / Role	Datatype /Secondary class	Multiplicity	Definition	Requirements
OperatorOfProcessingStation				Information about a Cash Processing Station operator, including the operator's identification and role	
Generalization		Contact		Information on an individual or department acting as point of contact for an organization.	
Attribute	operatorIdentification	string	1..1	Identification of the Cash Processing Machine operator.	
Attribute	operatorRole	string	1..1	Specifies the role of the Cash processing Machine operator, e.g. Quality Coordinator.	



**Note:** Reference Shared Common Library Business Message (BMS) Release 3.6 and eCom Domain Common Library Business Message (BMS) Release 3.6 for all common information.

#### 4.5.6 Cash Processing Machines Common – Cash Processing Machines Code

##### Class diagram

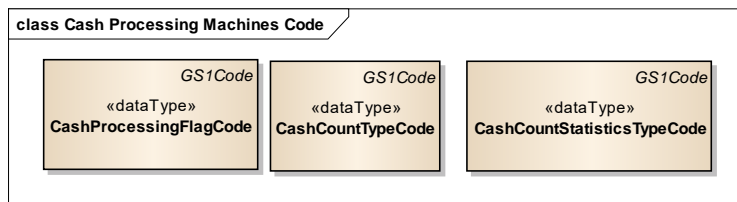

##### GDD report

Content	Attribute / Role	Datatype /Secondary class	Multiplicity	Definition	Requirements
CashCountStatisticsType Code				Type of statistics related to cash processing. Allowed code values are specified in GS1 Code List CashCountStatisticsTypeCode.	
Generalization		GS1Code			



Content	Attribute / Role	Datatype /Secondary class	Multiplicity	Definition	Requirements
CashCountTypeCode				Type of cash processing, e.g. single count, multi count, shredding. Allowed code values are specified in GS1 Code List CashCountTypeCode.	
Generalization		GS1Code			
CashProcessingFlagCode				Type of event that occurred during cash processing. Allowed code values are specified in GS1 Code List CashProcessingFlagCode.	
Generalization		GS1Code			

## 4.6 Enumerations (message specific)

Not applicable

## 4.7 Code Lists

Class	Codelist	Referenced in
CashProcessingEvent	CashProcessingFlagCode	<a href="http://apps.gs1.org/GDD/Pages/clDetails.aspx?semanticURN=urn:gs1:gdd:cl:CashProcessingFlagCode">http://apps.gs1.org/GDD/Pages/clDetails.aspx?semanticURN=urn:gs1:gdd:cl:CashProcessingFlagCode</a>
CashCountReport	CashCountTypeCode	<a href="http://apps.gs1.org/GDD/Pages/clDetails.aspx?semanticURN=urn:gs1:gdd:cl:CashCountTypeCode">http://apps.gs1.org/GDD/Pages/clDetails.aspx?semanticURN=urn:gs1:gdd:cl:CashCountTypeCode</a>
CashCountStatisticReport	CashCountStatisticsTypeCode	<a href="http://apps.gs1.org/GDD/Pages/clDetails.aspx?semanticURN=urn:gs1:gdd:cl:CashCountStatisticsTypeCode">http://apps.gs1.org/GDD/Pages/clDetails.aspx?semanticURN=urn:gs1:gdd:cl:CashCountStatisticsTypeCode</a>



**Note:** Refer to the Global Data Dictionary (GDD) for the code values.

# 5 Business Message Examples

## 5.1 Example 1

This is an example of the **Cash Count Notification** message.

The Cash Processing Machine generates one CashCountNotification file for each deposit report identified by unique shift number and batch number.

- The batch contained 2 parcels and 200 not enveloped banknotes in a parcel.
- No header cards were used, but the SSCC was labelled on each parcel. It was transmitted in the element additionalDepositUnitIdentifier.
- The not enveloped notes were assigned a dummy SSCC: 000000000000000000
- The reportPeriod represents the total processing time of the shift.
- The locationOfProcessingStation indicates the GLN of the branch where CPM machine is located.
- The machine is in the shredding mode (the shredder is active).
- The CPM room crew is composed by 2 operators and one supervisor.

The line items describe the two sorted parcels.

- The first parcel – line item 1:
  - The amountDespatched: 100 pieces of 10 EUR = 1000 EUR - the expected amount of the parcel
  - The amountAccepted: 99 pieces of 10 EUR = 990 EUR - the amount reported by the machine
  - The amountVariance: 1 piece of 10 EUR = 10 EUR
  - The reportPeriod represents processing time of the parcel
  - No header card used, the SSCC code of this parcel is: 400000100000123452
  - The detail of accepted amount: one itemDetail for each GTIN of accepted quantity:
  $50 + 40 + 8 + 1 = 102$ 
    - LineItemDetails = 1.1
      - gtin of 10 EUR ES1 FIT banknote: 04107001000759
      - quantityAccepted: 50

- outputLocation: GLN is not assigned, output stacker is identified with additionalPartyIdentification = Stacker1-2
- LineItemDetails = 1.2
  - gtin of 10 EUR ES2 FIT banknote: 04107001001008
  - quantityAccepted: 40
  - outputLocation: GLN is not assigned, output stacker is identified with additionalPartyIdentification = Stacker3-4
- LineItemDetails = 1.3
  - gtin of 10 EUR ES1 shredded banknote: 04107001000773
  - quantityAccepted: 8
  - outputLocation: GLN is not assigned, output stacker is identified with additionalPartyIdentification = Shredder
- LineItemDetails = 1.4
  - gtin of 10 EUR ES1 counterfeit banknote: 04107001000827
  - quantityAccepted: 1
  - outputLocation: GLN is not assigned, output stacker is identified with additionalPartyIdentification = Manual Inspection stacker

The second parcel – line item 2:

- The amountDespatched: 100 pieces of 10 EUR = 1000 EUR - the expected amount of the parcel
- The amountAccepted: 98 pieces of 10 EUR = 980 EUR - the amount reported by the machine
- The amountVariance: 2 pieces of 10 EUR = 20 EUR
- The reportPeriod represents processing time of the parcel
- No header card used, the SSCC code of this parcel is: 400000100000123476
- The cashCountEvent: Jam occurred during the parcel processing
  - processingFlagCode: JAM
- The detail of accepted amount: one itemDetail for each GTIN of accepted quantity: 50 + 40 = 80
  - LineItemDetails = 2.1
    - gtin of 10 EUR ES1 FIT banknote: 04107001000759
    - quantityAccepted: 50
    - outputLocation: GLN is not assigned, output stacker is identified with additionalPartyIdentification = Manual Inspection stacker
  - LineItemDetails = 2.2
    - gtin of 10 EUR ES2 FIT banknote: 04107001001008
    - quantityAccepted: 48
    - outputLocation: GLN is not assigned, output stacker is identified with additionalPartyIdentification = Manual Inspection stacker

Attribute	Value
<b>CashCountNotification</b>	
<b>Document</b>	
creationDateTime	2014-04-24T09:41:10Z

Attribute	Value
documentStatus	ORIGINAL
documentStructureVersion	3.4
documentActionCode	ADD
<b>Entity Identification (+cashCountNotificationIdentification)</b>	
entityIdentification	555000321
<b>Party Identification (+contentOwner)</b>	
gln	1111111111116
cashCountTypeCode	SINGLE_DENOMINATION_COUNTING
<b>DateTimeRangeType (+reportPeriod)</b>	
date (+beginDate)	2014-04-24
time (+beginTime)	09:30:10
date (+endDate)	2014-04-24
time (+endTime)	09:40:20
<b>ProcessingStation</b>	
Ecom_PartyIdentification	
gln	8052198010318
Ecom_PartyIdentification (+locationOfProcessingStation)	
gln	8052198002313
Code (+configurationMode)	STACKER_3X4
Code (+operationMode)	SHREDDING
<b>OperatorOfProcessingStation (+operator)</b>	
contactTypeCode	QC
personName	John Brown
operatorIdentification	2345
operatorRole	Operator
contactTypeCode	QC
personName	John Black
operatorIdentification	23456
operatorRole	Operator
contactTypeCode	MGR



Attribute	Value
personName	Kelly Koko
operatorIdentification	1234
operatorRole	Supervisor
<b>cashCountNotificationLineItem *1</b>	
lineItemNumber	1
<i>Amount (+amountDespached)</i>	1000
currencyCode	EUR
<i>Amount (+amountAccepted)</i>	990
currencyCode	EUR
<i>Amount (+amountVariance)</i>	10
currencyCode	EUR
<b><i>DateTimeRangeType (+reportPeriod)</i></b>	
date (+beginDate)	2014-04-24
time (+beginTime)	09:30:40
date (+endDate)	2014-04-24
time (+endTime)	09:32:20
<b>DepositUnitIdentification (+depositUnitIdentification)</b>	
headerCardIdentification	0
headerCardType	NO_HEADERCARD
AdditionalDepositUnitIdentification (+additionalDepositUnitIdentification)	
additionalDepositUnitIdentifier	40000010000012345
additionalDepositUnitIdentificationType	SSCC
<b>cashCountNotificationLineItemDetails *1.1</b>	
Quantity (+quantityAccepted)	50
measurementUnitCode	H87
GTIN (+cashArticleIdentification)	04107001000759
CashProcessingStation (+outputLocation)	Stacker1-2
additionalPartyIdentification	FOR_INTERNAL_USE_1
<b>cashCountNotificationLineItemDetails *1.2</b>	
Quantity (+quantityAccepted)	40
measurementUnitCode	H87

Attribute	Value
GTIN (+cashArticleIdentification)	04107001001008
CashProcessingStation (+outputLocation)	Stacker3-4
additionalPartyIdentification	FOR_INTERNAL_USE_2
<b>cashCountNotificationLineItemDetails *1.3</b>	
Quantity (+quantityAccepted)	6
measurementUnitCode	H87
GTIN (+cashArticleIdentification)	04107001000773
CashProcessingStation (+outputLocation)	Shredder
additionalPartyIdentification	FOR_INTERNAL_USE_3
<b>cashCountNotificationLineItemDetails *1.4</b>	
Quantity (+quantityAccepted)	3
measurementUnitCode	H87
GTIN (+cashArticleIdentification)	04107001000827
CashProcessingStation (+outputLocation)	Manual Inspection Stacker
additionalPartyIdentification	FOR_INTERNAL_USE_4
<b>cashCountNotificationLineItem *2</b>	
lineItemNumber	2
<i>Amount (+amountDespached)</i>	1000
currencyCode	EUR
<i>Amount (+amountAccepted)</i>	980
currencyCode	EUR
<i>Amount (+amountVariance)</i>	20
currencyCode	EUR
<b><i>DateTimeRangeType (+reportPeriod)</i></b>	
date (+beginDate)	2014-04-24
time (+beginTime)	09:33:10
date (+endDate)	2014-04-24
time (+endTime)	09:35:20
<b>DepositUnitIdentification (+depositUnitIdentification)</b>	
headerCardIdentification	0
headerCardType	NO_HEADERCARD



Attribute	Value
AdditionalDepositUnitIdentification (+additionalDepositUnitIdentification)	
additionalDepositUnitIdentifier	40000010000012374
additionalDepositUnitIdentificationType	SSCC
cashCountEvent	
processingFlagCode	JAM
Quantity (processedQuantity)	2
measurementUnitCode	H87
<b>cashCountNotificationLineItemDetails *2.1</b>	
Quantity (+quantityAccepted)	50
measurementUnitCode	H87
GTIN (+cashArticleIdentification)	04107001000759
CashProcessingStation (+outputLocation)	Manual Inspection stacker
additionalPartyIdentification	FOR_INTERNAL_USE_4
<b>cashCountNotificationLineItemDetails *2.2</b>	
Quantity (+quantityAccepted)	48
measurementUnitCode	H87
GTIN (+cashArticleIdentification)	04107001001008
CashProcessingStation (+outputLocation)	Manual Inspection stacker
additionalPartyIdentification	FOR_INTERNAL_USE_4

## 5.2 Example 2

This is an example of the **Cash Count Report** message.

One CashCountReport file for each deposit report identified by unique shift number and batch number.

- The reportPeriod represents the total processing time of the shift.
- The locationOfProcessingStation indicates the GLN of the branch where CPM machine is located.

The Receiver of this report is the Cash Management System identified with GLN: 8052198010004.

The line items describe the two sorted parcels.

The first item: 10 EUR ES2 FIT – line item 1:

- The quantityAccepted: 100 pieces of 10 EUR
- The amountAccepted: 1000 EUR
- gtin of 10 EUR ES1 FIT banknote: 04107001000759

The second item: 10 EUR ES1 FIT – line item 2:

- The quantityAccepted: 230 pieces 10 EUR - sorted amount
- The amountAccepted: 2300 EUR
- gtin of 10 EUR ES2 FIT banknote: 04107001001008

The third item: 10 EUR ES1 FIT – line item 3:

- The quantityAccepted: 50 pieces of 10 EUR
- The amountAccepted: 500 EUR
- The amountVariance: 0 EUR
- gtin of 10 EUR ES1 FIT banknote: 04107001001008

The fourth item: 10 EUR ES1 FIT – line item 4:

- The quantityAccepted: 1 piece of 10 EUR
- The amountAccepted: 10 EUR
- gtin of 10 EUR ES1 COUNTERFEIT banknote: 04107001000827

Attribute	Value
<b>CashCountReport</b>	
<b>Document</b>	
creationDateTime	2014-04-24T09:42:20Z
documentStatus	ORIGINAL
documentStructureVersion	3.4
documentActionCode	ADD
<b>Entity Identification (+cashCountReportIdentification)</b>	
entityIdentification	555000321
<b>PartyIdentification (+contentOwner)</b>	
gln	1111111111116
cashCountTypeCode	SHRED_ALL



Attribute	Value
<b><i>DateTimeRangeType (+reportPeriod)</i></b>	
date (+beginDate)	2014-04-24
time (+beginTime)	09:30:10
date (+endDate)	2014-04-24
time (+endTime)	09:40:20
<b><i>ProcessingStation</i></b>	
Ecom_PartyIdentification	
gln	8052198010318
Ecom_PartyIdentification (+locationOfProcessingStation)	
gln	8052198002313
Code (+operationMode)	SHREDDING
<b><i>TransactionalParty (+cashCountProtocolReceiver)</i></b>	
gln	8052198010004
<b>CashCountReportLineItem *1</b>	
lineItemNumber	1
Quantity (+quantityAccepted)	100
measurementUnitCode	H87
Amount (+amountAccepted)	1000
currencyCode	EUR
GTIN (+cashArticleIdentification)	04107001000759
<b>CashCountReportLineItem *2</b>	
lineItemNumber	2
Quantity (+quantityAccepted)	230
measurementUnitCode	H87
Amount (+amountAccepted)	2300
currencyCode	EUR
GTIN (+cashArticleIdentification)	04107001001008
<b>CashCountReportLineItem *3</b>	
lineItemNumber	4
Quantity (+quantityAccepted)	50
measurementUnitCode	H87



Attribute	Value
<i>Amount (+amountAccepted)</i>	500
currencyCode	EUR
<i>Quantity (+quantityShredded)</i>	50
measurementUnitCode	H87
<i>Amount (+amountShredded)</i>	500
currencyCode	EUR
GTIN (+cashArticleIdentification)	04107001001008
<b>CashCountReportLineItem *4</b>	
lineItemNumber	6
<i>Quantity (+quantityAccepted)</i>	1
measurementUnitCode	H87
<i>Amount (+amountAccepted)</i>	10
currencyCode	EUR
GTIN (+cashArticleIdentification)	04107001000827

### 5.3 Example 3

This is an example of the **Cash Count Statistic Report** message.

This message contains statistics about the rejected cash articles in a specific period – report Period for a specific Processing Station.

There are two groups containing 4 and 5 reject reasons, respectively. The report is based on prioritized scheme, which means that if there are multiple problems with a banknote, only the one with highest priority is listed. The total sum of rejects may correspond to the total reject rate. But depending on the operation mode, the result may be misleading if rejected banknotes are reprocessed and rejected again.

The report is accumulated per CPM and is not structured by denomination and/or series, because the denomination is not known or uncertain.

Attribute	Value
<b>CashCountStatisticReport</b>	
<b>Document</b>	
creationDateTime	2017-07-17T09:30:47Z
documentStatus	ORIGINAL
documentStructureVersion	3.4
documentActionCode	ADD
<b>Entity Identification (+cashCountStatisticReportIdentification)</b>	
entityIdentification	10885
<b>Party Identification (+contentOwner)</b>	
gln	111111111116
cashCountStatisticTypeCode	REJECT_STATISTICS
<b>DateTimeRangeType (+reportPeriod)</b>	
date (+beginDate)	2017-06-01
time (+beginTime)	09:00:47
date (+endDate)	2017-06-30
time (+endTime)	23:30:47
<b>ProcessingStation</b>	
Ecom_PartyIdentification	
gln	111111111185
Ecom_PartyIdentification (+locationOfProcessingStation)	
gln	111111111994
serialNumber	458gdfgy77K
Code (+configurationMode)	R_CDIL1

Attribute	Value
Code (+operationMode)	ONLINE-COUNTING
<b>GeneralStatisticInformation</b>	
Code (+statisticMeasurementType)	PRIORITIZED SCHEME
statisticMeasurementValue	6650
<b>RuntimeInformation</b>	
totalAvailabilityPercentage	78.5
Duration (+totalRuntime)	P1DT15H10M3S (1 day, 15 hours, 10 minutes, 3 seconds)
<b>runtimeDetails</b>	
Code (+runtimeType)	
Duration (+runtimeValue)	P1DT12H18M12S (1 day, 12 hours, 18 minutes, 12 seconds)
<b>DepositUnitIdentification</b>	
headerCardIdentification	0
HeaderCardTypeCodeType (+headerCardType)	NO_HEADER_CARD
<b>AdditionalDepositUnitIdentification</b>	
additionalDepositUnitIdentifier	400000100000123452
additionalDepositUnitIdentificationType	SSCC
Ecom_PartyIdentification (+cashOwner)	
gln	9999999999994
<b>CashCountStatisticReportLineItem *1</b>	
lineItemNumber	1
<i>fitnessLevel</i>	SINGLER_TRANSPORT
<i>Quantity (+totalQuantityProcessed)</i>	133
measurementUnitCode	H87
GTIN (+cashArticleIdentification)	04107001000742
<b>RejectionDetails 1.1</b>	
proportionalQuantityRejected	1.0
Quantity (+totalQuantityRejected)	32
measurementUnitCode	H87
Code (+rejectionReason)	CLOSE_FEED
<b>RejectionDetails 1.2</b>	



Attribute	Value
proportionalQuantityRejected	1.0
Quantity (+totalQuantityRejected)	74
measurementUnitCode	H87
Code (+rejectionReason)	ASYNCHRONOUS
<b>RejectionDetails 1.3</b>	
proportionalQuantityRejected	0.0
Quantity (+totalQuantityRejected)	10
measurementUnitCode	H87
Code (+rejectionReason)	JAM
<b>RejectionDetails 1.4</b>	
proportionalQuantityRejected	0.0
Quantity (+totalQuantityRejected)	17
measurementUnitCode	H87
Code (+rejectionReason)	TOO_LONG
<b>CashCountStatisticReportLineItem *2</b>	
lineItemNumber	2
<i>fitnessLevel</i>	SENSOR
<i>Quantity (+totalQuantityProcessed)</i>	2486
measurementUnitCode	H87
GTIN (+cashArticleIdentification)	04107001000919
<b>RejectionDetails 2.1</b>	
proportionalQuantityRejected	6.0
Quantity (+totalQuantityRejected)	338
measurementUnitCode	H87
Code (+rejectionReason)	R_HIGHRUN
<b>RejectionDetails 2.2</b>	
proportionalQuantityRejected	2.0
Quantity (+totalQuantityRejected)	85
measurementUnitCode	H87
Code (+rejectionReason)	R_SKEWRUN
<b>RejectionDetails 2.3</b>	
proportionalQuantityRejected	1.0

Attribute	Value
Quantity (+totalQuantityRejected)	64
measurementUnitCode	H87
Code (+rejectionReason)	R_CDIL1
<b>RejectionDetails 2.4</b>	
proportionalQuantityRejected	0.0
Quantity (+totalQuantityRejected)	4
measurementUnitCode	H87
Code (+rejectionReason)	R_CDIL2
<b>RejectionDetails 2.5</b>	
proportionalQuantityRejected	0.0
Quantity (+totalQuantityRejected)	9
measurementUnitCode	H87
Code (+rejectionReason)	R_DENOMINATION

## 5.4 Example 4

This is an example of the **Cash Packaging Report** message.

This is an example of creating a cardboard box from 10 bundles of ES1 20€ (5 created in the current shift and 5 created by the same machine in a previous shift) and manually inserted inside the machine.

- The reportPeriod represents the total processing time of the packaging shift.
- The locationOfProcessingStation indicates the GLN of the branch where CPM machine is located.
- The machine is in the standard processing mode, which is the processing of created bundles by the machine in the current/previous shift
- The Receiver of this report is the Cash Management System identified with GLN: 8052198010004.
- The CPM room crew is composed by 2 operators and one supervisor

The line items describe the bundle created in the current shift or manually inserted; one LineItem for each bundle.

The first bundle - line item 1:

- The reportUnitCreation: the shift when a new bundle was created
- The processingFlagCode: BUNDLE\_CREATION
- The processedQuantity: 1
- The cashPackagingReportLineItemDetails;
  - inputTradeItem GTIN of 20€ ES1 fit piece: 04107001001299
  - input tradeItemQuantity: 1000
  - outputTradeItem GTIN 20€ ES1 fit bundle: 04107001001435
  - output tradeItemQuantity: 1
  - output serialNumber: BUNDLECODE0000001
  - originProcessingStation GLN - the cash processing station that produced the input trade item: 8052198002153
  - outputLogisticUnit gross weight: 830 GRM

The second bundle - line item 2:

- The reportUnitCreation: the shift when a new bundle was created
- The processingFlagCode: BUNDLE\_CREATION
- The processedQuantity: 1
- The cashPackagingReportLineItemDetails;
  - inputTradeItem GTIN of 20€ ES1 fit piece: 04107001001299
  - input tradeItemQuantity: 1000
  - outputTradeItem GTIN of 20€ ES1 fit bundle: 04107001001435
  - output tradeItemQuantity: 1
  - output serialNumber: BUNDLECODE0000002
  - originProcessingStation GLN - the cash processing station that produced the input trade item: 8052198002153
  - outputLogisticUnit gross weight: 830 GRM
- The reportUnitCreation: the shift when a new bundle was created

The third bundle - line item 3:

Bundle created by the same machine in a previous/current shift: code readable from the machine

BUNDLE 4 - Created by machine BUNDLECODE0000004

BUNDLE 5 - Created by machine BUNDLECODE0000005

BUNDLE 6 - Created by machine BUNDLECODE0000006

BUNDLE 7 - Bundle created in a previous shift BUNDLECODE0000007

BUNDLE 8 - Bundle created in a previous shift BUNDLECODE0000008

BUNDLE 9 - Bundle created in a previous shift BUNDLECODE0000008

BUNDLE 10 - Bundle created in a previous shift BUNDLECODE0000010

Cardboard boxes section: each cashPackagingReportLineItemDetails represents a created cardboard box

- The reportUnitCreation: the shift when a new bundle was created
- The processingFlagCode: CARDBOX\_CREATION
- The processedQuantity: 1
- The cashPackagingReportLineItemDetails:
  - inputTradeItem – bundle 1 GTIN of 20€ ES1 fit bundle: 04107001001435
  - input tradeItemQuantity: 1
  - input serialNumber: BUNDLECODE0000001
  - inputTradeItem – bundle 2 GTIN of 20€ ES1 fit bundle: 04107001001435
  - input tradeItemQuantity: 1
  - input serialNumber: BUNDLECODE0000002
  - outputTradeItem GTIN of 20€ ES1 fit cardboard box: 04107001001473
  - output tradeItemQuantity: 1
  - originProcessingStation GLN - the cash processing station that produced the input trade item: 8052198002153
  - outputLogisticUnit SSCC: 380521980012302723
  - additionalLogisticUnitIdentification CASH-SSP: IT0100210123027271
  - outputLogisticUnit gross weight: 830 GRM

Attribute	Value
<b>CashPackagingReport</b>	
<b>Document</b>	
creationDateTime	2014-04-24T09:30:10Z
documentStatus	ORIGINAL
documentStructureVersion	3.4
documentActionCode	ADD
<b>Entity Identification (+cashPackagingReportIdentification)</b>	
entityIdentification	7855000315
<b>PartyIdentification (+contentOwner)</b>	
gln	1111111111116

Attribute	Value
<b><i>DateTimeRangeType (+reportPeriod)</i></b>	
date (+beginDate)	2014-04-24
time (+beginTime)	09:30:10
date (+endDate)	2014-04-24
time (+endTime)	09:40:20
<b><i>ProcessingStation</i></b>	
Ecom_PartyIdentification	
gln	8052198010318
Ecom_PartyIdentification (+locationOfProcessingStation)	
gln	8052198002313
Code (+operationMode)	STANDARD
<b><i>TransactionalParty (+cashPackagingReportReceiver)</i></b>	
gln	8052198010004
<b><i>OperatorOfProcessingStation (+operator)</i></b>	
contactTypeCode	QC
personName	John Brown
operatorIdentification	2345
operatorRole	Operator
contactTypeCode	QC
personName	John Black
operatorIdentification	23456
operatorRole	Operator
contactTypeCode	MGR
personName	Kelly Koko
operatorIdentification	1234
operatorRole	Supervisor
<b><i>CashPackagingReportLineItem *1</i></b>	
lineItemNumber	1
<b><i>DateTimeRangeType (+reportUnitCreation)</i></b>	
date (+beginDate)	2014-04-24
time (+beginTime)	09:31:10

Attribute	Value
date (+endDate)	2014-04-24
time (+endTime)	09:32:20
<b>CashProcessingEvent</b>	
processingFlagCode	BUNDLE_CREATION
Quantity (+processedQuantity)	1
measurementUnitCode	H87
<b>CashPackagingReportLineItemDetails*1.1</b>	
TransactionalTradeItem (+inputTradeItem)	
gtin	04107001001299
Quantity (+tradeItemQuantity)	1000
<b>TransactionalTradeItem (+outputTradeItem)</b>	
gtin	04107001001435
Quantity (+tradeItemQuantity)	1
<b>TransactionalItemData</b>	
serialNumber	BUNDLECODE0000001
<b>OriginProcessingStation</b>	
Ecom_PartyIdentification	
gln	8052198002153
<b>OutputLogisticUnit</b>	
<b>LogisticUnitMeasurement</b>	
UnitMeasurement	
measurementType	TOTAL_GROSS_WEIGHT
measurementValue	830
measurementUnitCode	GRM
<b>CashPackagingReportLineItem *2</b>	
lineItemNumber	2
DateTimeRangeType (+reportUnitCreation)	
date (+beginDate)	2014-04-24
time (+beginTime)	09:33:10
date (+endDate)	2014-04-24
time (+endTime)	09:34:20

Attribute	Value
CashProcessingEvent	
<b>processingFlagCode</b>	<b>BUNDLE_CREATION</b>
Quantity (+processedQuantity)	1
measurementUnitCode	H87
<b>CashPackagingReportLineItemDetails*2.1</b>	
<b>TransactionalTradeItem (+inputTradeItem)</b>	
gtin	04107001001299
Quantity (+tradeItemQuantity)	1000
<b>TransactionalTradeItem (+outputTradeItem)</b>	
gtin	04107001001435
Quantity (+tradeItemQuantity)	1
<b>TransactionalItemData</b>	
serialNumber	BUNDLECODE0000002
<b>OriginProcessingStation</b>	
<b>Ecom_PartyIdentification</b>	
gln	8052198002153
<b>OutputLogisticUnit</b>	
<b>LogisticUnitMeasurement</b>	
UnitMeasurement	
measurementType	TOTAL_GROSS_WEIGHT
measurementValue	830
measurementUnitCode	GRM
<b>CashPackagingReportLineItem *3</b>	
lineItemNumber	3
DateTimeRangeType (+reportUnitCreation)	
date (+beginDate)	2014-04-24
time (+beginTime)	09:31:10
date (+endDate)	2014-04-24
time (+endTime)	09:45:24
CashProcessingEvent	
processingFlagCode	CARDBOX_CREATION

Attribute	Value
Quantity (+processedQuantity)	1
measurementUnitCode	H87
<b>CashPackagingReportLineItemDetails*3.1</b>	
<b>TransactionalTradeItem (+inputTradeItem)</b>	
gtin	04107001001435
Quantity (+tradeItemQuantity)	1
<b>TransactionalItemData</b>	
serialNumber	BUNDLECODE0000001
<b>TransactionalTradeItem (+inputTradeItem)</b>	
gtin	04107001001435
Quantity (+tradeItemQuantity)	1
<b>TransactionalItemData</b>	
serialNumber	BUNDLECODE0000002
<b>TransactionalTradeItem (+outputTradeItem)</b>	
gtin	04107001001473
Quantity (+tradeItemQuantity)	1
<b>OriginProcessingStation</b>	
Ecom_PartyIdentification	
gln	8052198002153
<b>OutputLogisticUnit</b>	
sscc	380521980012302723
<b>LogisticUnitMeasurement</b>	
UnitMeasurement	
measurementType	TOTAL_GROSS_WEIGHT
measurementValue	8800
measurementUnitCode	GRM



## 6 Implementation Considerations

### 6.1 User Guide

The Functional User Guide contains more information about the structure and content of the Cash Processing Machines messages: <https://www.gs1.org/edi-xml/functional-user-guide/3-3/edi-other>

### 6.2 Message Specific Considerations

#### Code data types

A number of attributes in the Cash Processing Machines messages are defined as the Code data type. This type allows for use of bilaterally defined code lists, which should be mutually agreed between trading partners, GS1 does not specify the code list to be used. The Code type is used when there are multiple code lists that could be implemented depending e.g. on the individual agreement with the CPM device supplier or geopolitical region.

#### Cash Article Identification

The Cash Articles are identified using GS1 GTIN (Global Trade Item Number). It is preferred that these GTINs are assigned by the respective Central Banks – for consistency and to avoid misinterpretation of the identified cash items.

In the Eurosystem, a.k.a. euro zone GTINs are assigned to cash articles by the European Central Bank.

#### Cash Processing Station Identification

The output stacker should be identified by the GLN, but if it is not assigned, an additional identification can be provided.

#### Deposit Unit Identification

The Deposit Units are typically identified using Header Cards, hence the headerCard field is mandatory. However, if the Header Card is not used for any reason, the headerCardIdentification should be filled with "0" (one or more) and the headerCardType code value should be NO\_HEADER\_CARD.

The preferred option for the alternative Deposit Unit identifier will be the SSCC number, but if this is not feasible, an internal identifier provided by the customer can be used.

## 7 Summary of Changes

Any change in the GS1 standards is done based on the Work Request (WR) submitted by the GS1 User Companies or Member Organisations. All Work Requests are documented in the Work Request system available on the GS1 website: <http://wr.gs1.org>. The system is accessible to registered users. New visitors need to register first, to be able to access it. WRs can be searched by the number referenced in tables below, see: Search Work Requests. The number starts with the two last digits of the year when it was submitted, followed by the consecutive number within that year.



**Note:** WRs submitted earlier than February 2012 should be searched in Old Change Requests.

### 7.1 BMS Release 3.3

Change	Associated CR Number
First release	Not Applicable

## 7.2 BMS Release 3.4

Change	Associated WR
<p>Changed the occurrence of the inputTradeItem in the CashPackagingReportLineItemDetails class from 0..1 to 0..unbounded</p> <div style="border: 1px solid black; padding: 5px;"> <p><b>class CashPackagingReportLineItemDetails - maintenance view</b></p> <pre> classDiagram     class CashPackagingReportLineItemDetails {         &lt;&lt;association&gt;&gt;         + avpList : Ecom_AttributeValuePairList [0..1]     }     class CashPackagingTradeItem     CashPackagingReportLineItemDetails "0..1" -- "0..*" CashPackagingTradeItem : +inputTradeItem                     </pre> <p>Change: (New) 3.4 Changed multiplicity of inputTradeItem association from 0..1 to 0..* (WR 18-141)</p> </div>	<p><b>18-000141</b> Make the inputTradeItem in the Cash Packaging Report Repeatable</p>

## 7.3 BMS Release 3.5

No work requests. Document upgraded for release consistency.

## 7.4 BMS Release 3.5.1

No work requests. Document upgraded for release consistency.

## 7.5 BMS Release 3.6

No work requests. Document upgraded for release consistency.

# 8 Appendices

Not Applicable

# 9 Acknowledgements

## 9.1.1 Work Group

Function	Name	Company / organisation
Co-chair	Marc Matamoros	GS1 Spain
Co-chair	Thierry de la Breteche	Banque de France
Member	Aihedan Dilimulati	GS1 France
Member	Alexandre Rieucau	GS1 France
Member	Alfred Schmidt	Giesecke & Devrient GmbH
Member	Anders Grangard	GS1 Global Office
Member	Anne-Claire Krid	GS1 France
Member	Benjamin Couty	GS1 France
Member	Branko Safaric	GS1 Slovenia
Member	Carrie Wilkie	GS1 US
Member	Christine Gil	Banque de France
Member	Diana de Bernardy	GS1 France
Member	Ed Brindley	Glory Global Solutions, Inc.
Member	Edward Merrill	GS1 Global Office

Function	Name	Company / organisation
Member	Emanuela Casalini	GS1 Italy
Member	Emilie Sion	GS1 France
Member	Ewa Iwicka	GS1 Global Office
Member	Fany Palafox	GS1 Mexico
Member	Frank Pitter	Giesecke & Devrient GmbH
Member	Giada Necci	GS1 Italy
Member	Grzegorz Sokolowski	Institute of Logistics and Warehousing
Member	Jean-Luc Champion	GS1 Global Office
Member	Jochen Boy	Deutsche Bundesbank
Member	Jorge Fernandez Lara	Banco de México
Member	José Vélez Hernández	Banco de México
Member	Juergen Niemann	Deutsche Bundesbank
Member	Karl Cegner	GS1 Austria GmbH
Member	Manuel López	Banco de España
Member	Maria Angeles Marques	Banco de España
Member	Maria Elena Fernandez	Banco de España
Member	Martin Beno	GS1 Slovakia
Member	Mirko Fucci	Banca d'Italia
Member	Mirko Repetto	GS1 Italy
Member	Natascha Rossner (Pottier)	GS1 France
Member	Oscar Gerardo Gutiérrez Gómez	Banco de México
Member	Patric Bornschein	Deutsche Bundesbank
Member	Raoul Ngele	Deutsche Bundesbank
Member	Roman Strand	GS1 Germany
Member	Salima Bekraoui	GS1 Italy
Member	Salvatore Vassallo	Banca d'Italia
Member	Sergio Zuniga	GS1 Mexico
Member	Steven Rosenberg	GS1 US
Member	Tom Depoorter	GS1 Belgium & Luxembourg
Member	Valérie Dumez	GS1 France
Member	Valerie Marchand	GS1 France
Member	Xavier Pujol Xargay	GS1 Spain

### 9.1.2 Development Team Members

Function	Name	Organisation
GSMP Process Lead	David Buckley	GS1 Global Office
Technical Development Lead	Miklos Bolyky	GS1 Global Office
Peer Review	Mark Van Eeghem	GS1 Global Office

